

***YAESU***

*Radio for Professionals*

# ***FT-3165R***

# ***FT-3165E***

**Operating Manual**

VHF FM TRANSCEIVER

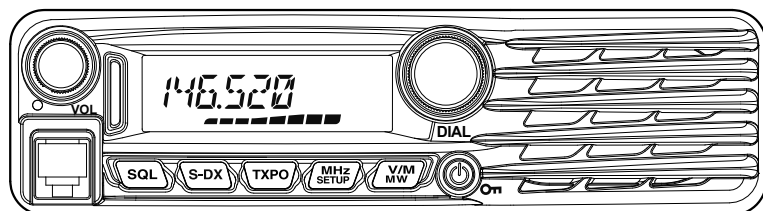

# Contents

|  |           |   |           |
|--|-----------|---|-----------|
| <b>FT-3165R/E Quick Reference Guide.....</b>         | <b>1</b>  | <b>Memory Operation.....</b>                          | <b>24</b> |
| <b>Introduction.....</b>                             | <b>2</b>  | Memory Storage.....                                   | 24        |
| New Features of the Yaesu FT-3165R/FT-3165E .....    | 2         | Split Memory.....                                     | 24        |
| Other Features .....                                 | 2         | Naming a Memory Channel .....                         | 24        |
| <b>Accessories &amp; Options .....</b>               | <b>3</b>  | Memory Recall.....                                    | 25        |
| Supplied Accessories .....                           | 3         | Memory Recall from the Microphone Keypad.....         | 25        |
| Optional Accessories.....                            | 3         | Moving Memory Data to the VFO .....                   | 25        |
| <b>Safety Precautions (Be Sure to Read).....</b>     | <b>4</b>  | Memory Only Mode.....                                 | 25        |
| <b>Installation.....</b>                             | <b>6</b>  | Masking Memories .....                                | 26        |
| Connecting the Microphone.....                       | 6         | Unmasking Memories .....                              | 26        |
| Connecting the Antenna .....                         | 6         | HOME Channel Memory .....                             | 26        |
| Mobile Installation.....                             | 6         | Changing the frequency of the home channel .....      | 26        |
| Power connection .....                               | 7         | <b>Scanning .....</b>                                 | <b>27</b> |
| Base Station Installation.....                       | 8         | Basic Scanner Operation.....                          | 27        |
| AC Power Supplies .....                              | 8         | Scan Resume Options .....                             | 27        |
| <b>Front Panel Controls &amp; Switches.....</b>      | <b>9</b>  | Memory Skip Scanning .....                            | 27        |
| Front Panel.....                                     | 9         | Preferential Memory Scan .....                        | 27        |
| <b>Microphone Switches.....</b>                      | <b>11</b> | Programmable Memory Scan (PMS).....                   | 27        |
| Microphone (SSM-85D).....                            | 11        | <b>Miscellaneous Settings.....</b>                    | <b>28</b> |
| <b>Rear Panel Connectors .....</b>                   | <b>12</b> | Keyboard Beeper.....                                  | 28        |
| Rear Panel.....                                      | 12        | Display Brightness.....                               | 28        |
| <b>Basic Operation .....</b>                         | <b>13</b> | Time-Out-Timer (TOT).....                             | 28        |
| Turning the Transceiver ON and OFF .....             | 13        | Automatic Power Off (APO).....                        | 28        |
| Adjusting the Audio Volume Level .....               | 13        | Busy Channel Lock-Out (BCLO) .....                    | 28        |
| Adjusting the Squelch Setting.....                   | 13        | TX Deviation Level .....                              | 28        |
| Lock Feature.....                                    | 13        | MIC Gain Setting .....                                | 28        |
| Frequency Navigation.....                            | 14        | Displaying the Supply Voltage.....                    | 28        |
| Using the Dial.....                                  | 14        | Displaying the Temperature.....                       | 28        |
| Using the SSM-85D Microphone .....                   | 14        | Band Edge Beeper .....                                | 28        |
| Channel Step Selection .....                         | 14        | <b>Reset Procedure/Clone .....</b>                    | <b>29</b> |
| Transmission .....                                   | 15        | Reset Procedure.....                                  | 29        |
| Adjusting the transmit power.....                    | 15        | All Reset.....  | 29        |
| Repeater Operation .....                             | 16        | Set Mode Resetting .....                              | 29        |
| Checking the Repeater Uplink (Input) Frequency... 16 |           | Clone.....  | 29        |
| Tone Calling (1750Hz) .....                          | 16        | <b>Setup (Menu) Mode .....</b>                        | <b>30</b> |
| <b>Advanced Operation .....</b>                      | <b>17</b> | <b>Maintenance.....</b>                               | <b>32</b> |
| Super DX and Noise cancelling function.....          | 17        | Care and maintenance .....                            | 32        |
| Priority Channel Scanning (Dual Watch).....          | 18        | Replacing the fuse.....                               | 32        |
| Programming the Key Assignments .....                | 19        | Replacing the fuse of the DC power supply cable .. 32 |           |
| CTCSS Operation.....                                 | 20        | <b>Specifications .....</b>                           | <b>33</b> |
| Tone Search.....                                     | 20        | <b>YAESU LIMITED WARRANTY .....</b>                   | <b>34</b> |
| DCS Operation .....                                  | 21        |   |           |
| DCS Search .....                                     | 21        |   |           |
| Weather Broadcast Reception.....                     | 22        |   |           |
| Severe Weather Alert Feature.....                    | 22        |   |           |
| EPCS (Enhanced Paging & Code Squelch)                |           |   |           |
| Operation.....                                       | 23        |   |           |
| Split Tone Operation .....                           | 23        |   |           |
| DTMF Operation.....                                  | 23        |   |           |

## FT-3165R/E Quick Reference Guide

### ② VOL Knob

Adjusts the audio volume level.

### ③ Frequency DIAL Knob

Selects the operating Frequency.

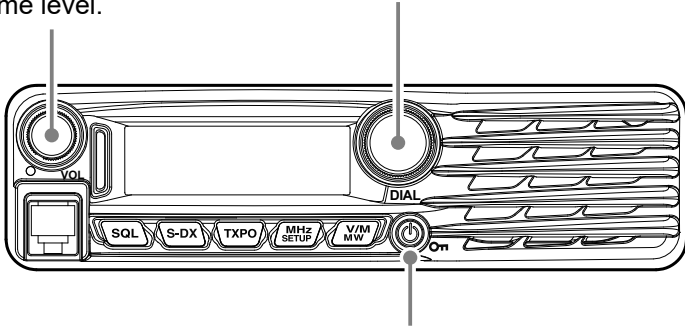

### ① Power Switch

Press and hold for one second.

### ④ Transmission Switch

Speak into the microphone in a normal voice level while pressing this switch.

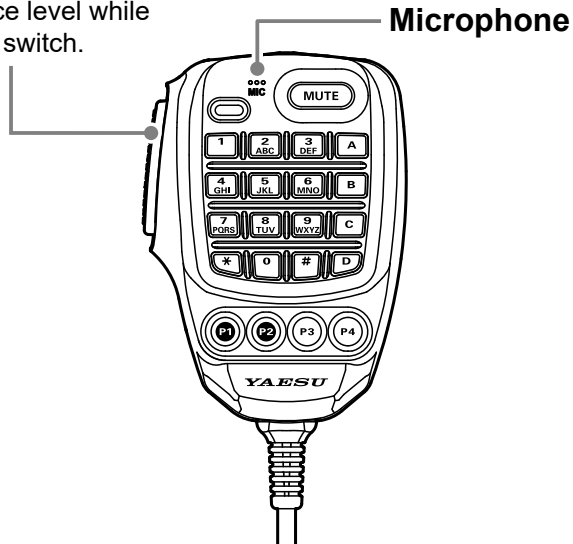

## Introduction

### New Features of the Yaesu FT-3165R/FT-3165E

- The new Super DX function increases the sensitivity of the RF amplifier when the received signal is weak, and expands the communication range.
- Installing the optional “Audio Signal Processing Unit SPU-1”, permits digitally processing the received audio signal to separate and remove noise. The voice can be brought out to produce clearer, easier-to-listen-to sound quality. Even weak signals that were previously inaudible due to noise can now be received clearly.
- A highly durable 5W high-quality, front loud speaker has been newly adopted to ensure uninterrupted communication, even in noisy environments.

### Other Features

- Optimizing the final power amplifier section and incorporating a small, highly efficient cooling fan, has achieved a transmission output of 65W.
- Expanded receiver coverage: 136-174MHz
- Keyboard entry of operating frequencies from the microphone
- 220 memories (199 “basic” memory channels, 10 sets of band-edge memory channels, and one “Home” channel) which can store repeater shifts, odd repeater shifts, CTCSS/DCS tones, and 8-character Alpha-Numeric labels for easy channel recognition
- 10 NOAA Weather Broadcast Channels, with Weather Alert and a Volume Control for the Weather Alert tone
- Built-in CTCSS and DCS Encoder/Decoder circuits
- Extensive Menu system, which allows customization of a number of transceiver performance characteristics

Additional features include a transmit Time-Out-Timer (TOT), Automatic Power-Off (APO), and Automatic Repeater Shift (ARS). Also included is an RF Squelch circuit that allows the owner to set the squelch to open at a programmed setting of the S-Meter, thus reducing guesswork in setting the squelch threshold.

Congratulations on your purchase of the FT-3165R/E. Whether this is your first rig, or if Yaesu equipment is already the backbone of your station, the Yaesu organization is committed to ensuring your enjoyment of this high-performance transceiver. It should provide you with many years of satisfying operation. Our dealer network and technical support personnel stand behind every product we sell, and we invite you to contact us should you require technical advice or assistance.

We recommend that you read this manual in its entirety prior to installing the FT-3165R/E, so that you fully understand the capabilities of your new transceiver.

## Supplied Accessories

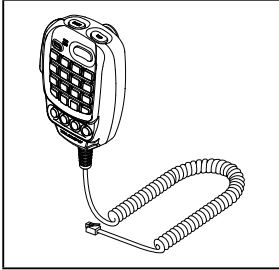

DTMF Microphone  
SSM-85D

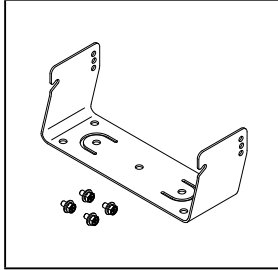

Mobile Mounting Bracket  
(Attachment screw set)

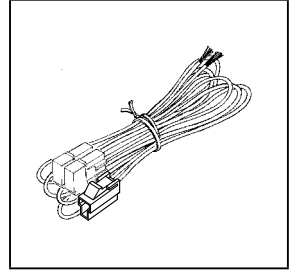

DC power cable w/Fuse

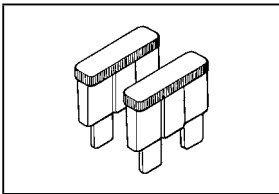

Spare fuse (25 A)  
(20 A, European version)

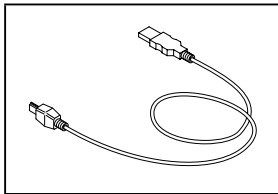

USB cable

Operating Manual

## Optional Accessories

DTMF Microphone (equivalent to the supplied microphone)  
Microphone  
Audio Signal Processing Unit  
High-Power External Speaker  
AC Power Supply (USA market only)  
AC Power Supply (USA/Asian market only)

SSM-85D  
MH-42C6J  
SPU-1  
MLS-100  
FP-1023  
FP-1030A

## Safety Precautions (Be Sure to Read)

**Be sure to read these important precautions, and use this product safely.**

Yaesu is not liable for any failures or problems caused by the use or misuse of this product by the purchaser or any third party. Also, Yaesu is not liable for damages caused through the use of this product by the purchaser or any third party, except in cases where ordered to pay damages under the laws.

### Types and meanings of the marks



#### **DANGER**

This mark indicates an imminently hazardous situation, which, if not avoided, could result in death or serious injury.



#### **WARNING**

This mark indicates a potentially hazardous situation, which, if not avoided, could result in death or serious injury.



#### **CAUTION**

This mark indicates a potentially hazardous situation, which, if not avoided, may result in minor or moderate injury or only property damage.

### Types and meanings of symbols



These symbols signify prohibited actions, which must not be done to use this product safely. For example:  indicates that the product should not be disassembled.



These symbols signify required actions, which must be done to use this product safely. For example:  indicates that the power plug should be disconnected.



## **DANGER**



**Do not use the device in "regions or aircrafts and vehicles where its use is prohibited" such as in hospitals and airplanes.**  
This may exert an impact on electronic and medical devices.



**Do not use this product while driving or riding a motorbike. This may result in accidents.**  
Make sure to stop the car in a safe location first before use if the device is going to be used by the driver.



**Do not operate the device when flammable gas is generated.**  
Doing so may result in fire and explosion.



**Never touch the antenna during transmission.**  
This may result in injury, electric shock and equipment failure.



**Do not transmit in crowded places in consideration of people who are fitted with medical devices such as heart pacemakers.**  
Electromagnetic waves from the device may affect the medical device, resulting in accidents caused by malfunctions.



**When an alarm goes off with the external antenna connected, cut off the power supply to this radio immediately and disconnect the external antenna from this radio.**  
If not, this may result in fire, electric shock and equipment failure.



**Do not touch any liquid leaking from the liquid display with your bare hands.**  
There is a risk of chemical burns occurring when the liquid comes into contact with the skin or gets into the eyes. In this case, seek medical treatment immediately.



## **WARNING**



**Do not use voltages other than the specified power supply voltage.**  
Doing so may result in fire and electric shock.



**Do not transmit continuously for long periods of time.**  
This may cause the temperature of the main body to rise and result in burns and failures due to overheating.



**Do not dismantle or modify the device.**  
This may result in injury, electric shock and equipment failure.



**Do not handle the power plug and connector etc. with wet hands. Also do not plug and unplug the power plug with wet hands.**  
This may result in injury, liquid leak, electric shock and equipment failure.











**When smoke or strange odors are emitted from the radio, turn off the power and disconnect the power cord from the socket.**  
This may result in fire, liquid leak, overheating, damage, ignition and equipment failure. Please contact our company amateur customer support or the retail store where you purchased the device.









**Keep the power plug pins and the surrounding areas clean at all times.**  
This may result in fire, liquid leak, overheating, breakage, ignition etc.









**Disconnect the power cord and connection cables before incorporating items sold separately and replacing the fuse.**  
This may result in fire, electric shock and equipment failure.

-  **Never cut off the fuse holder of the DC power cord.**  
This may cause short-circuiting and result in ignition and fire.
-  **Do not use fuses other than those specified.**  
Doing so may result in fire and equipment failure.
-  **Do not allow metallic objects such as wires and water to get inside the product.**  
This may result in fire, electric shock and equipment failure.
-  **Do not place the device in areas that may get wet easily (e.g. near a humidifier).**  
This may result in fire, electric shock and equipment failure.
-  **When connecting a DC power cord, pay due care not to mix up the positive and negative polarities.**  
This may result in fire, electric shock and equipment failure.
-  **Do not use DC power cords other than the one enclosed or specified.**  
This may result in fire, electric shock and equipment failure.
-  **Do not bend, twist, pull, heat and modify the power cord and connection cables in an unreasonable manner.**  
This may cut or damage the cables and result in fire, electric shock and equipment failure.
-  **Do not pull the cable when plugging and unplugging the power cord and connection cables.**  
Please hold the plug or connector when unplugging. If not, this may result in fire, electric shock and equipment failure.

-  When transmitting, keep the antenna at least 1.8m away from your body. Do not use modified or damaged antennas.
-  **RF Exposure:** This device should be operated with a minimum separation distance of 20cm (8 inches) between the equipment and a person's body.
-  **Refrain from using headphones and earphones at a loud volume.**  
Continuous exposure to loud volumes may result in hearing impairment.
-  **Do not use the device when the power cord and connection cables are damaged, and when the DC power connector cannot be plugged in tightly.**  
Please contact our company amateur customer support or the retail store where you purchased the device as this may result in fire, electric shock and equipment failure.
-  **Follow the instructions given when installing items sold separately and replacing the fuse.**  
This may result in fire, electric shock and equipment failure.
-  **Do not use the device when the alarm goes off.**  
For safety reasons, please pull the power plug of the DC power equipment connected to the product out of the AC socket.
-  Never touch the antenna as well. This may result in fire, electric shock and equipment failure due to thunder.

## CAUTION

-  **Do not place this device near a heating instrument or in a location exposed to direct sunlight.**  
This may result in deformation and discoloration.
-  **Do not place this device in a location where there is a lot of dust and humidity.**  
Doing so may result in fire and equipment failure.
-  **Stay as far away from the antenna as possible during transmission.**  
Long-term exposure to electromagnetic radiation may have a negative effect on the human body.
-  **Do not wipe the case using thinner and benzene etc.**  
Please use a soft and dry piece of cloth to wipe away the stains on the case.
-  **Keep out of the reach of small children.**  
If not, this may result in injuries to children.
-  **Do not put heavy objects on top of the power cord and connection cables.**  
This may damage the power cord and connection cables, resulting in fire and electric shock.
-  **Do not transmit near the television and radio.**  
This may result in electromagnetic interference.
-  **Do not use optional products other than those specified by our company.**  
If not, this may result in equipment failure.
-  **When using the device in a hybrid car or fuel-saving car, make sure to check with the car manufacturer before using.**  
The device may not be able to receive transmissions normally due to the influence of noises from the electrical devices (inverters etc.) fitted in the car.

-  **For safety reasons, switch off the power and pull out the DC power cord connected to the DC power connector when the device is not going to be used for a long period of time.**  
If not, this may result in fire and overheating.
-  **Do not throw or subject the device to strong impact forces.**  
This may result in equipment failure.
-  **Do not put this device near magnetic cards and video tapes.**  
The data in the cash card and video tape etc. may be erased.
-  **Do not turn on the volume too high when using a headphone or earphone.**  
This may result in hearing impairment.
-  **Do not place the device on an unsteady or sloping surface, or in a location where there is a lot of vibration.**  
The device may fall over or drop, resulting in fire, injury and equipment failure.
-  **Do not stand on top of the product, and do not place heavy objects on top or insert objects inside it.**  
If not, this may result in equipment failure.
-  **Do not use a microphone other than those specified when connecting a microphone to the device.**  
If not, this may result in equipment failure.
-  **Do not touch the heat radiating parts.**  
When used for a long period of time, the temperature of the heat radiating parts will get higher, resulting in burns when touched.
-  **Do not open the case of the product except when replacing the fuse and when installing items sold separately.**  
This may result in injury, electric shock and equipment failure.

## Installation

### Connecting the Microphone

Connect the supplied SSM-85D microphone to the FT-3165R/E. Plug the microphone connector into the MIC jack on the front panel until it clicks.

**Note:** When disconnecting the microphone, pull the cable while pressing the connector latch.

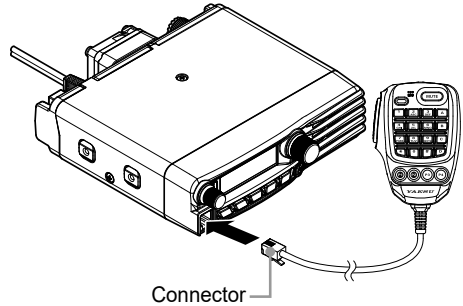

### Connecting the Antenna

Connect the coaxial cable to the body. Plug the coaxial cable jack into the ANT terminal on the rear panel of the body, then rotate and tighten it.

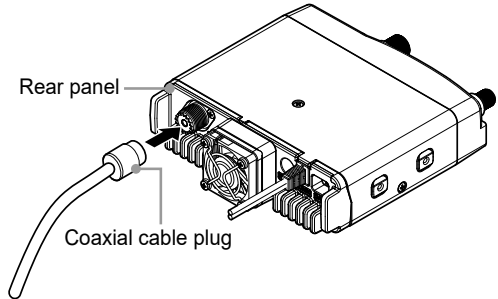

### Mobile Installation

The FT-3165R/E must only be installed in vehicles having a 13.8 Volt negative ground electrical system. Mount the transceiver where the display, controls, and microphone are easily accessible, using the supplied mounting bracket.

The transceiver may be installed in almost any location, but should not be positioned near a heating vent nor anywhere where it might interfere with driving (either visually or mechanically).

Make sure to provide plenty of space on all sides of the transceiver so that air can flow freely around the transceiver's case. Refer to the diagrams showing proper installation procedures.

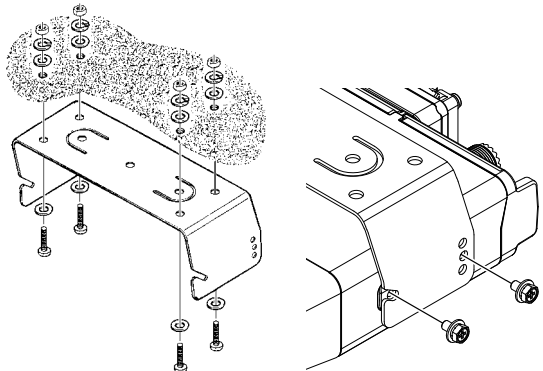



## Power connection

To minimize voltage drop and avoid blowing the vehicle's fuses, connect the supplied DC power cable directly to the battery terminals. Do not attempt to defeat or bypass the DC cable fuse - it is there to protect you, your transceiver, and your vehicle's electrical system.

### **Warning!**

**Never apply AC power to the power cable of the FT-3165R/E, nor DC voltage greater than 15.8 Volts. When replacing the fuse, only use a 25-A (20-A, European version) fuse. Failure to observe these safety precautions will void the Limited Warranty on this product.**

- Before connecting the transceiver, check the voltage at the battery terminals while revving the engine. If the voltage exceeds 15 Volts, adjust the vehicle's voltage regulator before proceeding with installation.
- Connect the **RED** power cable lead to the **POSITIVE (+)** battery terminal, and the **BLACK** power cable lead to the **NEGATIVE (-)** terminal. If you need to extend the power cable, use #12 AWG or larger insulated, stranded copper wire. Solder the splice connections carefully, and wrap the connections thoroughly with insulating electrical tape.
- Before connecting the cable to the transceiver, verify the voltage and polarity at the voltage at the transceiver end of the DC cable, using a DC voltmeter. Now connect the transceiver to the DC cable.

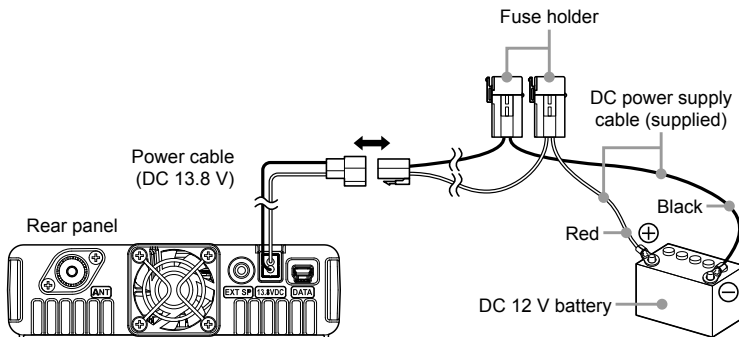

### **Warning!**

- Do not use a DC power supply cable other than the one that is supplied or specified.
- Do not place anything on the DC power supply cable or step on it.
- Do not use the DC power supply cable with the fuse holder cut off.
- Do not reverse the polarity (positive and negative) when connecting the battery.

# Installation

## Base Station Installation

The FT-3165R/E is ideal for base station use as well as in mobile installations. The FT-3165R/E is specifically designed to integrate into your station easily, using the following information as a reference.

### AC Power Supplies

Operation of the FT-3165R/E from an AC line requires a power source capable of providing at least 20 Amps continuously at 13.8 Volts DC. The FP-1023 (USA market only) and FP-1030A (USA/Asian market only) AC Power Supplies are available from your Yaesu dealer to satisfy these requirements. Other well-regulated power supplies may be used as well, if they meet the above voltage and current specifications.

Use the DC power cable supplied with the transceiver to make the power connection to the power supply. Connect the **RED** power cable lead to the **POSITIVE (+)** power supply terminal, and connect the **BLACK** power cable lead to the **NEGATIVE (-)** power supply terminal.

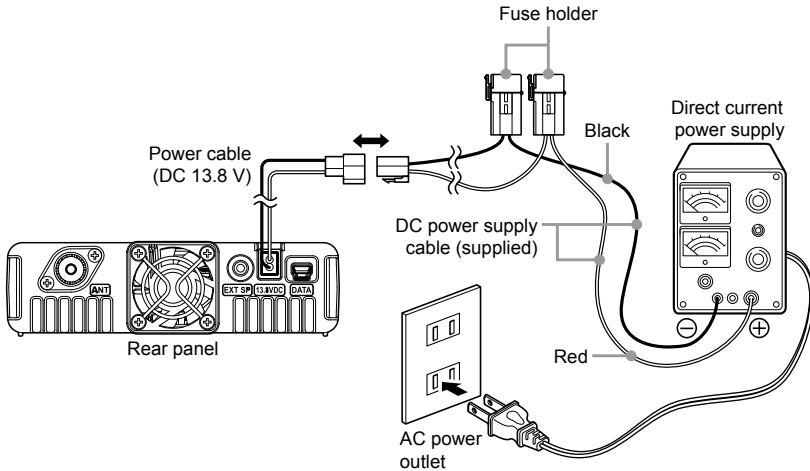

## Front Panel

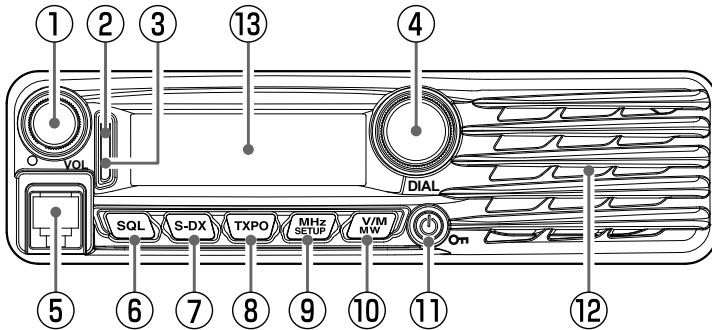

- ① **VOL knob**  
Rotate the knob to adjust the audio volume level.
- ② **S-DX (Super DX) indicator**  
Lights white when the Super DX function is in operation.  
(When the optional Audio Signal Processing Unit SPU-1 is installed, the indicator Lights blue when the “Super DX function” and “Noise Canceling” are in operation.)
- ③ **BUSY/TX indicator**  
Indicates the transmit/receive status with a three-color combination indicator:  
**Green:** Receiving audio  
**Red:** Transmitting audio  
**Blinking Blue:** Receiving signals with unmatched audio conditions\*  
\* • Receiving signals with unmatched tone frequency or DCS code.  
• Receiving a signal level less than the RF Squelch S-meter level setting.
- ④ **DIAL Knob**
  - Allows setting the operating frequency.
  - Allows selecting the desired items for setup, memory registration, etc.
- ⑤ **MIC Jack**  
Connect the provided microphone cable.
- ⑥ **SQL key**  
Press the key briefly and rotate the **DIAL** knob to set the squelch level.
- ⑦ **S-DX key**  
Press this key briefly to enable the Super DX function and increase sensitivity.  
Installation of the optional “SPU-1”, provides even greater noise reduction and clearer audio.
- ⑧ **TXPO key**  
Press the key briefly then rotate the **DIAL** knob to select the transmit power (HIGH: 65W / MID: 30W / LOW: 5W).

## Front Panel Controls & Switches

⑨ **MHZ SETUP** key

This key instigates tuning in 1MHz steps (the MHz digits will blink on the display). Press and hold this key in for over one second to activate the Setup (Menu) Mode.

⑩ **V/M MW** key

Press this key briefly to switch between VFO mode and memory mode. Press and hold the key for over one second to display the memory registration screen.

⑪ **Power On** key

Press and hold in this key for over one second to switch the power between ON and OFF. Briefly pressing the key while the transceiver is turned ON engages or releases the key lock.

⑫ **Speaker**

The internal loud speaker provides 5 watts of audio.

⑬ **LCD Display**

The main digits on the display may show the operating frequency, memory name, or any of many parameters during Menu setup.

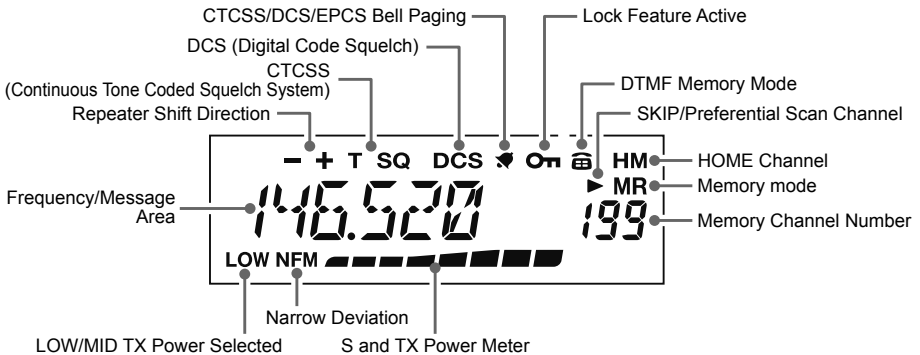

## Microphone (SSM-85D)

- ① **MIC**  
Speak into the microphone during transmission.
- ② **TX LED**  
Lights red while pressing PTT switch.
- ③ **PTT**  
Press and hold the PTT switch to transmit, and release it to receive.  
Press this key during the set mode to exit the set mode.
- ④ **DWN**  
Press this key to move the frequency or memory channel lower by one step, press and hold it to start scanning.
- ⑤ **UP**  
Press this key to move the frequency or memory channel up by one step, press and hold it to start scanning.
- ⑥ **MUTE**  
Press this key to mute the receive audio. Press it again to unmute the audio.
- ⑦ **DTMF keypad**  
Press these keys during transmit to enter and send a DTMF sequence. The following operations can be performed during receive.  
0 - 9 : Enter the frequency or memory channel number.  
A, B, C, D : No function assigned.  
\* : No function assigned.  
# : Confirms the entered frequency or memory channel number.

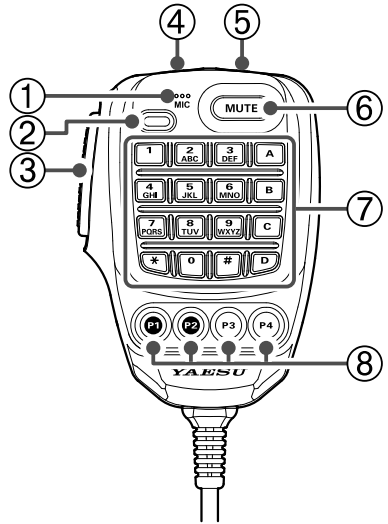

- ⑧ **Program keys (P1/P2/P3/P4)**

The default function settings of the [P1] / [P2] / [P3] / [P4] keys are shown in the table below.

| Key | Function                        |   |
|-----|---------------------------------|---|
| P1  | SQL OFF                         | Opens the squelch (SQL off)   |
| P2  | HOME CH                         | Recalls the HOME channel  |
| P3  | REV                             | Reverses the transmit and receive frequencies in repeater mode or split memory. |
| P4  | WX (USA version)                | Switches operation to the Weather Channel Bank                                  |
|     | T CALL (European/Asian version) | Transmits the T-CALL (1750Hz)   |

Reprogram the [P1], [P2], [P3], and [P4] keys for other functions, if desired (see page 19).

## Rear Panel

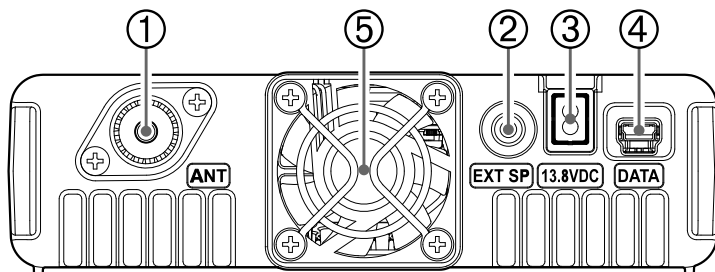

① **ANT Coaxial Socket**

Connect a 144MHz antenna to this type-M (SO-239) socket using 50-Ohm coaxial cable and a type-M (PL-259) plug. Make sure the antenna is designed specifically for use on the operating frequency.

② **EXT SP Jack**

This 2-contact 3.5-mm mini phone jack provides receiver audio output for an optional external speaker. The audio impedance is 4 Ohms, and the level varies according to the setting of the front panel **VOL** control. Inserting a plug into this jack disables audio from the transceiver's internal speaker.

③ **13.8 V DC Cable**

Connect the provided DC power supply cable (with fuse attached).

④ **DATA Jack**

Use this jack when updating the firmware. When a new firmware update for the FT-3165R/E is available, go to the YAESU website to download the programming data and update the FT-3165R/E to its newest state.

⑤ **Cooling Fan**

## Turning the Transceiver ON and OFF

Press and hold this key to switch the power ON or OFF.

When the power is ON, press this key briefly to engage, or release the key lock.

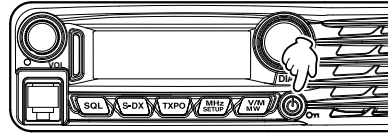

May compose a desired Opening Message (up to 8 characters) via Setup Menu Item "15 OPEN MSG" see page 30 for details.

## Adjusting the Audio Volume Level

Rotate the **VOL** knob to adjust the receiver volume. Clock-wise rotation increases the audio output level.

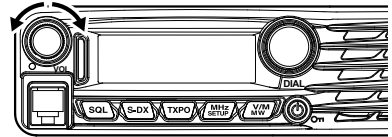

## Adjusting the Squelch Setting

1. Press the **SQL** key, and then rotate the **DIAL** knob to select the Squelch level.
2. Press the **SQL** key again.

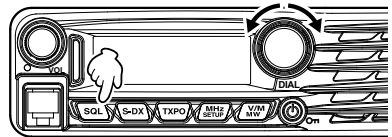

**Note:** A special "RF Squelch" feature is provided on this transceiver. This feature allows setting the squelch so that only signals exceeding a certain S-meter level will open the squelch. For details, refer to the Advanced Manual (download from the Yaesu website).

## Lock Feature

To activate the key-lock feature, press the **On** key. The "On" icon will appear on the LCD.

To cancel key-lock, press the **On** key again.

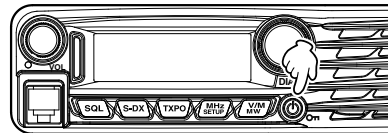

To select which keys are locked, use the Setup Menu Item "36 LOCK" see page 31 for details.

## Basic Operation

### Frequency Navigation

#### Using the Dial

Rotating the **DIAL** knob allows tuning in the pre-programmed steps. Clockwise rotation tunes the frequency upwards, whereas counterclockwise rotation tunes the frequency downwards.

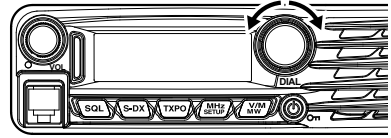

Press the **MHz SETUP** key momentarily, and then rotate the **DIAL** knob, to change the frequency steps to 1MHz per step.

#### Using the SSM-85D Microphone

##### Using the [UP] and [DWN] key:

Pressing **[UP]** momentarily, tunes the frequency upwards. Whereas pressing **[DWN]** momentarily tunes the frequency in the downward direction.

##### Using the number keys:

Use the **[0]** to **[9]** number keys to directly input the frequency. There is no “decimal point” key on the SSM-85D keypad. However, there is a short-cut for frequencies ending in zero: press the **[#]** key after the last non-zero digit.

##### **Examples:**

To enter 146.520MHz, press **[1]** ➡ **[4]** ➡ **[6]** ➡ **[5]** ➡ **[2]**

To enter 146.000MHz, press **[1]** ➡ **[4]** ➡ **[6]** ➡ **[#]**

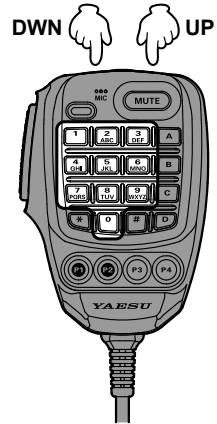

### Channel Step Selection

The frequency tuning step of the **DIAL** and the microphone **[UP]**/**[DWN]** keys can be changed.

1. Press and hold the **MHz SETUP** key for over one second.  
The Setup menu appears.
2. Rotate the **DIAL** knob to select “**37 STEP**”, then press the **MHz SETUP** key.
3. Rotate the **DIAL** knob to select the frequency step.
4. Press and hold the **MHz SETUP** key for over one second to save the new settings and return to normal operation.

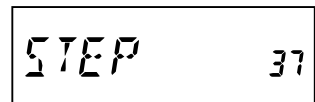



## Transmission

1. Press and hold **PTT** on the microphone.  
The BUSY/TX indicator lights red.

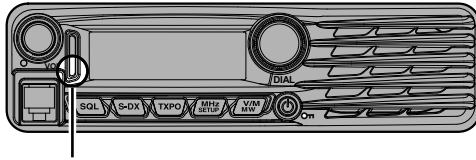

The lower portion lights red

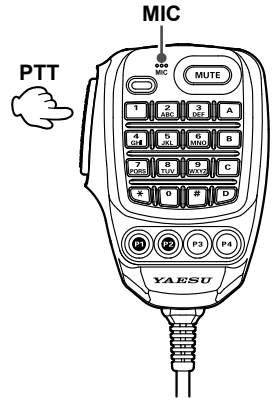

2. Speak into **MIC** on the microphone.  
**Note:** Keep the microphone about 2 inches (5cm) away from your mouth.  
The sensitivity (gain) of the microphone can be adjusted. For details, refer to the Advanced Manual (download from the Yaesu website).

3. Release **PTT**.  
The BUSY/TX indicator turns OFF and the transceiver returns to the receive mode.  
**Caution:** Do not continue transmitting for a prolonged period. The transceiver may overheat, resulting in malfunction or injury.  
**Note:** "ERROR" appears if you attempt to transmit on an unavailable frequency.

## Adjusting the transmit power

When communicating with a nearby station, the transmit power level may be lowered to reduce the battery power consumption.

1. Press the **TXPO** key.
2. Rotate the **DIAL** knob to select the transmit power.

**Note:** The default setting: HIGH

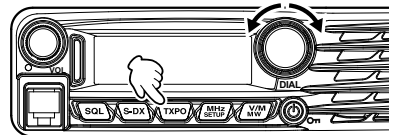

HIGH (65 W)



MID (30 W)

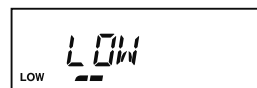

LOW (5 W)

3. Press the **TXPO** key to save the new setting and exit to normal operation.

### Repeater Operation

The FT-3165R/E includes the ARS (Automatic Repeater Shift) function, which permits communication through repeaters automatically, by simply setting the receiver to the repeater frequency.

1. Tune to the repeater frequency.
2. Press the **PTT** to transmit.

During transmission, the signal including a 100.0Hz tone is emitted on the frequency offset from the receive frequency by 0.6MHz.

**Note:** The repeater tone and offset settings may be changed from the Setup Menu.

- 22 RPT SFT** ➡ Allows setting the repeater shift direction.
- 23 RPT ARS** ➡ Deactivates the ARS function.
- 24 RPT FREQ** ➡ Allows changing the repeater shift frequency offset.
- 28 SQL TYPE** ➡ Selects Tone Encode and Decode Mode.
- 29 TONE FRQ** ➡ Sets CTCSS Tone Frequency.

#### ***Checking the Repeater Uplink (Input) Frequency***

It is often helpful to be able to check the uplink (input) frequency of a repeater, to see if the calling station is within direct (“Simplex”) range.



Press the program key [**P3**] of the microphone (in factory default setting). The display will shift to the repeater uplink frequency. While listening on the repeater input frequency, the repeater offset icon will blink. Press the [**P3**] key again to revert to normal monitoring of the repeater downlink (output) frequency.



#### ***Tone Calling (1750Hz)***

If the transceiver is FT-3165E (European version), press and hold in the program key [**P4**] of the microphone (in factory default setting) to generate a 1750Hz burst tone to access the European repeater. The transmitter will automatically be activated, and a 1750Hz audio tone will be superimposed on the carrier. Once access to the repeater has been gained, release the [**P4**] key, and use the **PTT** for activating the transmitter thereafter. To access the repeaters which require a 1750Hz burst tone with the FT-3165R (USA/Asian versions), the program key on the microphone may be used to serve as the “**T CALL**” key instead. To change the configuration of this key, use setup menu [**16 PGM P1**], [**17 PGM P2**], [**18 PGM P3**] or [**19 PGM P4**].

#### **How to assign “T CALL” function**

1. Press and hold the  key.
2. Rotate the **DIAL** knob to select [**16 PGM P1**], [**17 PGM P2**], [**18 PGM P3**] or [**19 PGM P4**] key to assign a function, then press the  key.
3. Rotate the **DIAL** knob to select “**T CALL**”.
4. Press and hold the  key to save the setting and return to normal operation.

## Super DX and Noise cancelling function

The Super DX function increases the sensitivity of the RF amplifier when the received signal is weak, expanding the calling range. In addition, by installing the optional “Audio Signal Processing Unit SPU-1”\*, the received audio signal can be digitally processed to separate and remove noise. The voice can be brought out to produce clearer, easier-to-listen sound quality. Even weak signals that were previously inaudible due to noise can now be received clearly.

\*Refer to the Advanced Manual (download from the Yaesu website) for installation of the SPU-1.

Press the **S-DX** key to activate the Super DX function, the indicator on the left of the display will light white.

(When the SPU-1 is installed, the **S-DX** key also turns the “Noise Canceling” function ON, and the indicator will light blue.)

Press the **S-DX** key again to return the receiver to normal sensitivity. The indicator light will turn OFF.

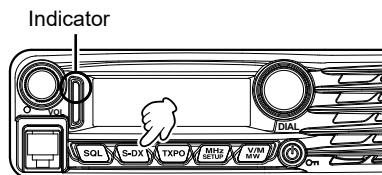



### Priority Channel Scanning (Dual Watch)





The FT-3165R/E's scanning features include a two-channel scanning capability which allows operating on a VFO, Memory channel, or Home channel, while periodically checking a user-defined Memory Channel for activity. If a station received on the Memory Channel is strong enough to open the Squelch, the scanner will pause on that station in accordance with the Scan-Resume mode setting of Menu item "25 SCAN RSM".

Assigning the "DW" function to a programmable key ([P1]/[P2]/[P3]/[P4]) on the microphone (SSM-85D).

#### How to assign "DW" function

1. Press and hold the  key.
2. Rotate the **DIAL** knob to select [16 PGM P1], [17 PGM P2], [18 PGM P3] or [19 PGM P4] key to assign a function, then press the  key.
3. Rotate the **DIAL** knob to select "DW".
4. Press and hold the  key to save the setting and return to normal operation.

Here is the procedure for activating Priority Channel Dual Watch operation:

1. Press the  key to switch to memory mode.
2. Press and hold the  key, then select the memory channel you wish to be the "Priority" channel.
3. Press the  key.  
The "PRI CH?" will appear on the display.
4. Press the  key again. The "P" notation will appear on the "100MHz" frequency digit on the display; indicating it is the Priority channel.

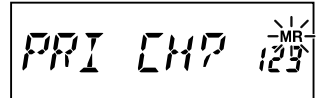
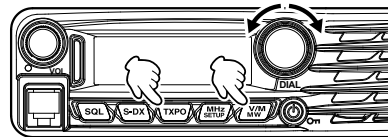

5. Now set the FT-3165R/E for operation on another memory channel, Home channel, or on a VFO frequency.
6. Press the program key of the microphone to which "DW" function is assigned. The display will remain on the VFO, the selected memory channel, or the Home channel, but every 5 seconds the FT-3165R/E will check the Priority Channel for activity.  
**Note:** During Dual Watch operation, the decimal points of the frequency display blink.
7. To cancel Dual Watch operation, press the program key of the microphone to which "DW" function is assigned.

## Programming the Key Assignments



Default FT-3165R/E key functions have been assigned to the Microphone [P1]/[P2]/[P3]/[P4] keys at the factory. The user may change these key function assignments, if quick access to another function is desired.

**Note:** The default setting: [P1] - SQL OFF  
 [P2] - HOME  
 [P3] - REV  
 [P4] - WX CH (T CALL: Asian/European version)

To change the assignments for the programmable keys:

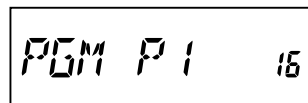
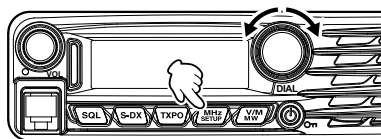
1. Press and hold the  key for over one second.  
 The Setup menu appears.
2. Rotate the **DIAL** knob to select the Menu Item to configure the desired microphone button: (“16 PGM P1”, “17 PGM P2”, “18 PGM P3” or “19 PGM P4”).



3. Press the  key.
4. Rotate the **DIAL** knob to select a function (see below) then press the  key.
  - SQL OFF** : Open the Squelch to allow un-muted reception
  - HOME** : Recall the home channel
  - WX CH** : Switches operation to the Weather channels bank
  - CD SRCH** : Engages the Tone or DCS Search Scanning feature
  - SCAN** : Engages the Scan operation
  - T CALL** : Activates 1750 Hz Tone Burst
  - TX POWER** : Set the transmission power level
  - REV** : Reverses the transmit and receive frequencies in repeater mode or split memory
  - DW** : Operation setting of dual receive function
5. Press and hold in the  key for one second to save the new setting and exit to normal operation.



You may assign Set Mode items to the Microphone [P1]/[P2]/[P3]/[P4] buttons, as well, to do this:

1. Press and hold in the  key for one second to enter the Set mode.
2. Rotate the **DIAL** knob to select the Set Mode Item that you wish to assign to the key as a Menu short cut.
3. Press and hold in the Microphone's [P1], [P2], [P3] or [P4] key for one second to assign the Set Mode Item to that button.
4. Now you can recall this preferred Set Mode Item by simply pressing the Microphone button momentarily.

## Advanced Operation

### CTCSS Operation

FT-3165R/E is equipped with the CTCSS (Continuous Tone-coded Squelch System) that allows audio to be heard only when receiving signals containing a tone corresponding to the tone squelch menu setting. By matching the CTCSS tone with the partner station in advance, quiet standby monitoring is possible.

1. Press and hold the  key for over one second.  
The Setup menu appears.
2. Rotate the **DIAL** knob to select “**28 SQL TYPE**”, then press the  key.

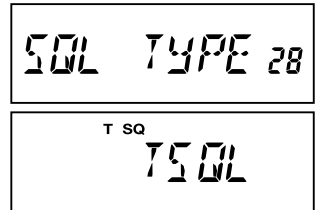
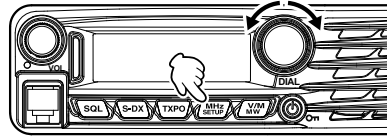

3. Rotate the **DIAL** knob to select “**TSQL**”, then press and hold the  key for over one second.

“**T SQ**” is displayed on the screen. The squelch opens only when receiving tone signals of the set frequency.

**Note:** The CTCSS setting can be changed from the Setup Menu.

**29 TONE FRQ**  The tone frequency can be selected from 50 frequencies.

**5 BELL**  A bell tone (beep) may be set to sound when signals containing a corresponding CTCSS tone are received.



### Tone Search

When the CTCSS tone being transmitted by another station is not known, you can tune the transceiver to the incoming signal and activate tone scan to search for and identify the tone being used.

**Note:** For details, refer to the Advanced Manual (download from the Yaesu website).

## DCS Operation

FT-3165R/E is equipped with a DCS (Digital Coded Squelch) function that allows audio to be heard only when signals containing the corresponding DCS code are received. By matching the DCS code with the partner stations beforehand, a quiet receive standby is possible.

1. Press and hold the  key for over one second.  
The Setup menu appears.
2. Rotate the **DIAL** knob to select “**28 SQL TYPE**”, then press the  key.

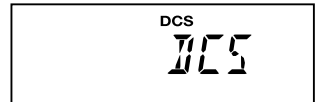
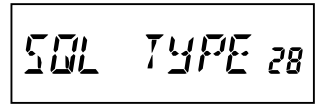
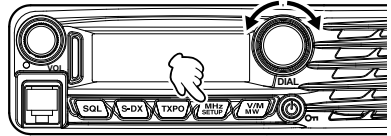

3. Rotate the **DIAL** knob to select “**DCS**”, then press and hold the  key for over one second.

“**DCS**” is displayed on the screen. The squelch opens only when receiving a signal containing the corresponding DCS code.

**Note:** The DCS setting can be changed from the Setup Menu.

**30 DCS CODE**  The DCS code can be selected from 104 codes.

**5 BELL**  A bell tone (beep) may be set to sound when signals containing a corresponding DCS code are received.

### DCS Search

When the DCS code being transmitted by another station is not known, you can tune the transceiver to the incoming signal and activate DCS code scan to search for and identify the DCS code being used.

**Note:** For details, refer to the Advanced Manual (download from the Yaesu website).

### Weather Broadcast Reception

The FT-3165R/E includes a unique feature which allows reception of weather broadcasts in the 160MHz frequency range. Ten standard Weather Broadcast channels are preloaded into a special memory bank.

To listen to a Weather Broadcast Channel (Example: When “WX” is assigned to [P4]):

1. Press the Microphone [P4] key to recall the Weather Broadcast channels.

**Note:** In the USA model, the [P4] key one of the programmable keys, is assigned (default setting) as the “WX Broadcast” one-touch access key. Please note that if you change/assign another function to the [P4] key, one-touch access to the WX channel will be unavailable.

2. Turn the **DIAL** knob to select the desired Weather Broadcast channel.

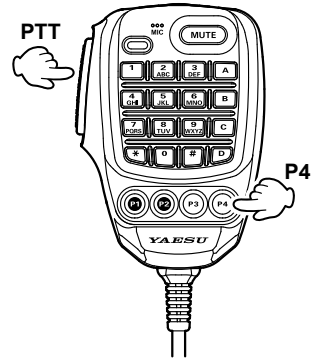

| CH | Frequency  | CH | Frequency  |
|----|------------|----|------------|
| 1  | 162.550MHz | 6  | 162.500MHz |
| 2  | 162.400MHz | 7  | 162.525MHz |
| 3  | 162.475MHz | 8  | 161.650MHz |
| 4  | 162.425MHz | 9  | 161.775MHz |
| 5  | 162.450MHz | 10 | 163.275MHz |

3. To scan the other channels for activity, press the Microphone **PTT** switch.
4. To exit to normal operation, press the [P4] key again. Operation will return to the VFO or Memory channel in operation before you began Weather Broadcast operation.

### **Severe Weather Alert Feature**

In the event of extreme weather disturbances, such as storms and hurricanes, NOAA (the National Oceanic and Atmospheric Administration) sends a weather alert accompanied by a 1050Hz tone and subsequent weather report on one of the NOAA weather channels. You may enable this feature via Setup Menu Item “**43 WX ALERT**” see page 32 for details.



The following features are also available:

### **EPCS (Enhanced Paging & Code Squelch) Operation**

Use the pager code consisting of two CTCSS tones to exchange communications with specified stations.

**Note:** For details, refer to the Advanced Manual (download from the Yaesu website).

### **Split Tone Operation**

The FT-3165R/E can be operated in a “Split Tone” configuration that enables operation on repeaters using a mix of both CTCSS and DCS control via the Setup menu.

**Note:** For details, refer to the Advanced Manual (download from the Yaesu website).

### **DTMF Operation**

DTMF tones (Dual Tone Multi Frequencies) are the tones you hear when dialing from a telephone keypad. The FT-3165R/E transceiver can transmit the DTMF codes by using the keys on the microphone or recalling registered number strings from memories.

The maximum of 16-digit DTMF codes can be registered in up to 10 memory channels. It is convenient to register telephone patch numbers, and network linking sequences to the DTMF memory channels.

**Note:** For details, refer to the Advanced Manual (download from the Yaesu website).

## Memory Operation

The FT-3165R/E provides a wide variety of memory system resources. These include:

- 199 “basic” memory channels, numbered “1” through “199”.
- A “Home” channel, providing storage and quick recall of one prime frequency.
- 10 sets of band-edge memories, also known as “Programmable Memory Scan” channels, labeled “L0/U0” through “L9/U9”.

Each memory may be appended with an alphanumeric label of up to 8 characters, for quick channel recognition.

## Memory Storage

1. In the VFO mode, select the desired frequency, repeater shift, CTCSS/DCS tone, and TX power level.
2. Press and hold the  key for one second. A memory number will appear in the bottom right corner of the display.

**Note:** If the channel number is blinking, there currently is no data stored on that channel; if the channel number is not blinking, that channel is currently “occupied” by other frequency data.

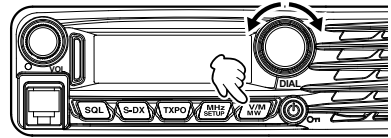

3. Within five seconds of pressing the  key, use the **DIAL** knob to select the desired memory into which you wish to store the frequency.

**Note:** While operating in the Memory Storage mode, the keypad of the SSM-85D Microphone may be used to enter the memory channel number directly.

To do this, enter the desired Channel Number on the keypad and then press the [#] key. Refer to the “For example” of the “Memory Recall from the Microphone Keypad” on next page.

4. Press the  key again, this time momentarily, to store the displayed data into the selected memory channel slot.
5. To store additional frequencies, repeat steps 1 through 4, remembering to set the repeater shift, CTCSS/DCS tone, and TX power level, as appropriate.

### Split Memory

A separate transmit frequency may be registered to a memory channel to which a receive frequency has already been registered.

**Note:** For details, refer to the Advanced Manual (download from the Yaesu website).

### Naming a Memory Channel

You may also append an alphanumeric “Tag” (label) to each memory, to aid in recollection of the channel’s use (such as club name, etc.).

**Note:** For details, refer to the Advanced Manual (download from the Yaesu website).

## Memory Recall

Once the desired frequencies are stored into memory channels, switch from the “VFO” mode to the “Memory Recall” mode, to operate on the just-stored memory channels.

1. Press the  $\left(\frac{V/M}{M/W}\right)$  key, repeatedly if necessary, until the “MR” icon and a memory channel number appear on the display; this indicates that the “Memory Recall” mode is now engaged.
2. When more than one memory has been stored, use the **DIAL** knob to select any of the programmed memories for operation.

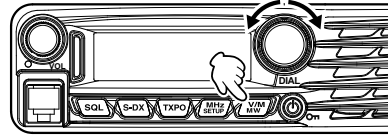

**Note:** Alternatively, the microphone **[UP]** or **[DWN]** key may be used to step or scan through the available memories. When using the microphone keys, press the key momentarily to move one step up or down; press and hold the **[UP]** or **[DWN]** key for one second to begin memory scanning.

### Memory Recall from the Microphone Keypad

While operating in the Memory Recall mode, the keypad of the SSM-85D Microphone may be used for direct recall of memory channels.

To do this, enter the desired Channel Number on the keypad and then press the **[#]** key.

**For example:** To recall Memory Channel “5”, press **[5] → [#]**

To recall Memory Channel “123”, press **[1] → [2] → [3] → [#]**

You may also recall Programmable Memory Scan (PMS) channels (“L0/U0” through “L9/U9”) by entering the channel numbers listed in the below table:

|    |     |    |     |    |     |    |     |    |     |    |     |    |     |    |     |    |     |    |     |
|----|-----|----|-----|----|-----|----|-----|----|-----|----|-----|----|-----|----|-----|----|-----|----|-----|
| L1 | 201 | L2 | 203 | L3 | 205 | L4 | 207 | L5 | 209 | L6 | 211 | L7 | 213 | L8 | 215 | L9 | 217 | L0 | 219 |
| U1 | 202 | U2 | 204 | U3 | 206 | U4 | 208 | U5 | 210 | U6 | 212 | U7 | 214 | U8 | 216 | U9 | 218 | U0 | 220 |

### Moving Memory Data to the VFO

Data stored on memory channels can easily be moved to the VFO.

1. Select the memory channel containing the frequency data to be moved to the VFO.
2. Press and hold the  $\left(\frac{V/M}{M/W}\right)$  key for one second, and then press the  $\left(\frac{MHZ}{SETUP}\right)$  key.  
The “VFO WRT?” will appear on the display.
3. Press the  $\left(\frac{MHZ}{SETUP}\right)$  key, the data will now have been copied to the VFO.

**Note:** For details, refer to the Advanced Manual (download from the Yaesu website).

### Memory Only Mode

Once memory channel programming has been completed, you may place the transceiver in a “Memory Only” mode, whereby VFO operation is impossible.

To place the radio into the Memory Only mode, turn the transceiver OFF. Now press and hold in the  $\left(\frac{V/M}{M/W}\right)$  key while turning the transceiver ON. The VFO and Home Channel will now be disabled.



To return to normal operation, repeat the above power-on procedure.

**Note:** For details, refer to the Advanced Manual (download from the Yaesu website).

## Memory Operation

### Masking Memories

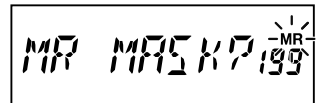
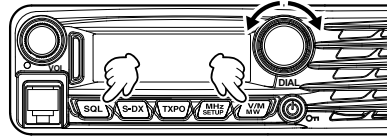

There may be situations where you want to “Mask” memories so they are not visible during memory selection or scanning. (except for Memory Channel “1”, the Priority Channel, and the Home Channel).

1. In the Memory Recall mode, press and hold the  key for one second, then rotate the **DIAL** knob to select the memory channel you wish to mask.
2. Press the  key.  
The erase confirmation screen appears.
3. Press the  key.  
The previously selected memory will be “masked”.



**Note:** Press any key, other than , to cancel the memory mask.

### Unmasking Memories

1. To Unmask a hidden memory, in the Memory Recall mode, press and hold the  key for one second.
2. Rotate the **DIAL** knob to select the masked memory number.
3. Press the  key to restore the memory channel data.

### HOME Channel Memory

A convenient one-touch “Home” channel memory is available to simplify returning to an often used frequency.

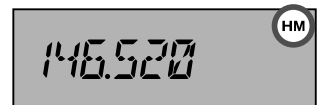
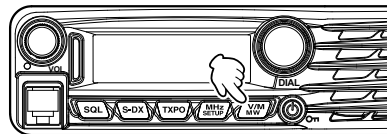

To recall the Home channel, just press the  key, repeatedly if necessary, until the “**HM**” icon appears on the display; this indicates that the Home Channel has been recalled.

**Note:** When shipped from the factory, the Home Channel is set to 146.520MHz (USA version) or 145.000MHz (Asian/ European version).



### Changing the frequency of the home channel

The default frequency setting of the home channel can be changed.

1. In the VFO mode, tune to the desired Home channel frequency.
2. Press and hold the  key for one second, and then press the  key.  
The overwrite confirmation screen appears.
3. Press the  key.  
The home channel frequency is overwritten.

## Basic Scanner Operation

Before activating the scanner, make sure that the Squelch is set to silence the background noise when no signal is present. Scanning is not possible while the Squelch is open (if noise or signals are being heard).

Scanning may be started or stopped using the microphone [UP] or [DWN] key.

The following techniques are used for scanning:

- In the **VFO mode**, press and hold either the [UP] or [DWN] key for one second, to start upward or downward scanning of the band.
- In the **Memory mode**, press and hold either the [UP] or [DWN] key for one second to start channel scanning toward a higher or lower-numbered memory channel, respectively.
- Scanning pauses when a signal opens the squelch, and the decimal point on the display will blink.

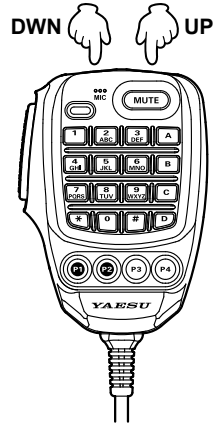

- To halt the scan manually, the easiest way is to push the PTT switch on the microphone momentarily (no transmission will occur while you are scanning). The scan may also be halted manually by pressing the microphone [UP] or [DWN] key, or the **V/M MW** key.

### **Scan Resume Options**

Select which of the three resume scan modes is to be performed after the scanning stops.

**Note:** For details, refer to the Advanced Manual (download from the Yaesu website).

### **Memory Skip Scanning**

Memory channels which you do not want to receive can be skipped during scanning.

**Note:** For details, refer to the Advanced Manual (download from the Yaesu website).

### **Preferential Memory Scan**

Set up a "Preferential Scan List" of channels which you can "flag" within the memory system.

**Note:** For details, refer to the Advanced Manual (download from the Yaesu website).

### **Programmable Memory Scan (PMS)**

Using the dedicated PMS memory channels, only the frequencies within the specified frequency range will be scanned.

**Note:** For details, refer to the Advanced Manual (download from the Yaesu website).

## Miscellaneous Settings

### Keyboard Beeper

A key/button beeper provides useful audible feedback whenever a key/button is pressed. If you want to turn the beeper OFF (or back ON again).

**Note:** If you want to turn the beeper OFF (or back ON again), see Setup Menu Item “**3 BEEP KEY**” on page 30.

### Display Brightness

Set the brightness level of the display.

**Note:** See Setup Menu Item “**7 DIMMER**” on page 30.

### Time-Out-Timer (TOT)

The “Time-Out Timer” (TOT) feature is designed to force the transceiver into the “receive” mode after a preset time period of continuous transmission (the default is 3 minutes).

**Note:** See Setup Menu Item “**38 TOT**” on page 31.

### Automatic Power Off (APO)

The transceiver can be set to automatically power OFF when there is no operation for a period.

**Note:** See Setup Menu Item “**1 APO**” on page 30.

### Busy Channel Lock-Out (BCLO)

The BCLO feature prevents the transmitter from being activated whenever a signal strong enough to break through the “noise” squelch is present on the frequency.

**Note:** See Setup Menu Item “**2 BCLO**” on page 30.

### TX Deviation Level

The receiver bandwidth and transmit deviation may be reduced when operating on closely spaced frequencies (channel spacing of 12.5 or 15kHz). The reduced transmitter deviation will minimize adjacent channel interference to other users.

**Note:** See Setup Menu Item “**42 WIDTH**” on page 32.

### MIC Gain Setting

The sensitivity (gain) of the microphone can be adjusted.

**Note:** See Setup Menu Item “**12 MIC GAIN**” on page 30.

### Displaying the Supply Voltage

Display the Power Supply voltage.

**Note:** See Setup Menu Item “**40 VOLT**” on page 32.

### Displaying the Temperature

Indicates the current temperature inside the transceiver.

**Note:** See Setup Menu Item “**39 TEMP**” on page 31.

### Band Edge Beeper

The FT-3165R/E will automatically “beep” when the receiver’s band edge is encountered during scanning (either in standard VFO scanning or during PMS operation). You may additionally enable this feature (band edge beeper) when the frequency reaches the band edge while selecting the VFO frequency manually, using the **DIAL** knob.

**Note:** For details, refer to the Advanced Manual (download from the Yaesu website).

## Reset Procedure

In some instances of erratic or unpredictable operation, the cause may be corruption of data in the microprocessor (due to static electricity, etc.). If this happens, resetting the microprocessor may restore normal operation. Note that all memories will be erased if you do a complete microprocessor reset, as described below.

### All Reset

To clear all memories and other settings to factory defaults:

1. Turn the transceiver OFF.
2. Press and hold the **TXPO**, **MHZ SETUP**, and **V/M MW** keys while turning the transceiver on. The “ALL RESET PUSH V/M KEY” notation will scroll on the display.



ALL RESET PUSH V/M KEY

3. Press the **V/M MW** key momentarily to reset all settings to their factory defaults (press any other key to cancel the Reset procedure).

### Set Mode Resetting

To reset the Set (Menu) mode settings to their factory defaults, while leaving other settings unchanged.

Restore the following setting items to the defaults: (See above if “All Reset” is required)

|             |             |             |             |             |
|-------------|-------------|-------------|-------------|-------------|
| 9 DT EDIT   | 13 MEM NAME | 15 OPEN MSG | 20 PAG CD-R | 21 PAG CD-T |
| 22 RPT SFT  | 24 RPT FREQ | 26 SCAN SKP | 28 SQL TYPE | 29 TONE FRQ |
| 30 DCS CODE | 31 DCS INV  | 32 SQL EXP  | 33 SQL RF   | 37 STEP     |
| 42 WIDTH    |             |             |             |             |

1. Turn the transceiver OFF.
2. Press and hold the **TXPO** and **MHZ SETUP** keys while turning the transceiver on. The “SET MODE RESET PUSH V/M KEY” notation will scroll on the display.



SET MODE RESET PUSH V/M KEY

3. Press the **V/M MW** key momentarily to reset the Set (Menu) mode settings to their factory defaults (press any other key to cancel the Reset procedure).

## Clone

The FT-3165R/E includes a convenient “Clone” feature, which allows the memory and configuration data from one transceiver to be transferred to another FT-3165R/E.

This can be particularly useful when configuring a number of transceivers for a public service operation.

**Note:** For details, refer to the Advanced Manual (download from the Yaesu website).

## Setup (Menu) Mode

The FT-3165R/E Setup (Menu) mode, already described in parts of many previous chapters, is easy to activate and setup. The Menus may be used to configure many of transceiver parameters, some of which have not been detailed previously. Use the following procedure to activate the Setup (Menu) mode:

1. Press and hold the **MHz SETUP** key for one second to enter the Setup menu.
2. Rotate the **DIAL** knob to select the Menu Item to be adjusted.
3. Press the **MHz SETUP** key momentarily to enable adjustment of the selected Menu item, and then rotate the **DIAL** knob to perform the actual adjustment.

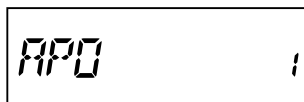
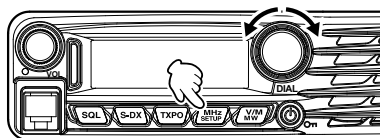

4. After completing your selection and adjustment, press and hold the **MHz SETUP** key for one second to exit the Setup menu and resume normal operation.

**Note:** For details, refer to the Advanced Manual (download from the Yaesu website).

| Menu Item    | Function   | Available Values                | Default  |
|--------------|--|---------------------------------|----------|
| 1: APO       | Enables/Disables the Automatic Power Off feature.                            | 0.5H to 12H (0.5H step)/<br>OFF | OFF      |
| 2: BCLO      | Enables/Disables the Busy Channel Lock-Out feature.                          | ON/OFF                          | OFF      |
| 3: BEEP KEY  | Enables/Disables the key beeper.   | KEY+SCAN/KEY/OFF                | KEY+SCAN |
| 4: BEEP EDG  | Enables/Disable the Band-edge beeper while scanning.                         | ON/OFF                          | OFF      |
| 5: BELL      | Selects the CTCSS/DCS/EPCS Bell Ringer repetitions.                          | 1 to 20/CONTINUE/OFF            | OFF      |
| 6: CLK TYPE  | Shifting of the CPU clock frequency.   | A/B                             | A        |
| 7: DIMMER    | Setting of the front panel display illumination level.                       | MAX/MID 1/MID 2/<br>OFF         | OFF      |
| 8: DT AUTO   | Enables/Disables the DTMF Autodialer feature.                                | MANUAL/AUTO                     | MANUAL   |
| 9: DT EDIT   | Loading of the DTMF Autodialer Memories.                                     | ---                             | ---      |
| 10: DT DELAY | Setting of the DTMF Autodialer TX Delay Time.                                | 50/250/450/750/1000             | 450 MS   |
| 11: DT SPEED | Setting of the DTMF Autodialer Sending Speed.                                | 50/100                          | 50 MS    |
| 12: MIC GAIN | Adjust the microphone gain level.  | LEVEL 1 to 9                    | LEVEL 5  |
| 13: MEM NAME | Programming an Alpha/Numeric label for a Memory Channel.                     | ---                             | ---      |
| 14: MW MODE  | Selects the method of selecting of channels for Memory Storage.              | NEXT CH/LOWER CH                | NEXT CH  |
| 15: OPEN MSG | Selects the Opening Message that appears when the transceiver is powered ON. | OFF/DC/MESSAGE                  | MESSAGE  |



## Setup (Menu) Mode

| Menu Item    | Function   | Available Values   | Default  |
|--------------|--|--|----------|
| 16: PGM P1   | Programming the function assigned to Microphone [P1] key.  | SQL OFF<br>HOME<br>WX CH<br>CD SRCH<br>SCAN<br>T CALL<br>TX POWER<br>REV<br>DW<br>Setup Menu Item #1 to 44 | SQL OFF  |
| 17: PGM P2   | Programming the function assigned to Microphone [P2] key.  |  | HOME     |
| 18: PGM P3   | Programming the function assigned to Microphone [P3] key.  |  | REV      |
| 19: PGM P4   | Programming the function assigned to Microphone [P4] key.  |  | ×        |
| 20: PAG CD-R | Setting the Receiver Pager Code for the Enhanced CTCSS Paging & Code Squelch function.               | ---  | 05 47    |
| 21: PAG CD-T | Setting the Transmitting Pager Code for the Enhanced CTCSS Paging & Code Squelch function.           | ---  | 05 47    |
| 22: RPT SFT  | Sets the Repeater Shift direction.   | -RPT/+RPT/SIMPLEX  | SIMPLEX  |
| 23: RPT ARS  | Activates/Deactivates the Automatic Repeater Shift feature.  | ON/OFF   | ON       |
| 24: RPT FREQ | Sets the magnitude of the Repeater Shift.  | 0.00 - 150.00 (MHz)  | 0.60MHz  |
| 25: SCAN RSM | Selects the Scan Resume mode.  | BUSY/HOLD/2-10 (SEC)   | 5.0 SEC  |
| 26: SCAN SKP | Selects the Memory Scan mode.  | OFF/SKIP/SELECT  | OFF      |
| 27: DW REVRT | Enables/Disables the "Priority Channel Revert" feature.  | ON/OFF   | OFF      |
| 28: SQL TYPE | Selects the Tone Encoder and/or Decoder mode.  | TONE/TSQL/DCS/<br>RV TONE/PAGER/OFF  | OFF      |
| 29: TONE FRQ | Setting of the CTCSS Tone Frequency.   | 67.0 to 254.1 (Hz)   | 100.0Hz  |
| 30: DCS CODE | Setting of the DCS code.   | 104 standard DCS codes   | 023      |
| 31: DCS INV  | Select a combination of DCS inversion codes in terms of communication direction.                     | NORMAL/INVERT/<br>BOTH   | NORMAL   |
| 32: SQL EXP  | Sets the squelch type separately for transmission and reception.                                     | ON/OFF   | OFF      |
| 33: SQL RF   | Adjusts the RF Squelch threshold level.  | OFF/S1 to S8   | OFF      |
| 34: TS MUTE  | Enables/Disables the receiver audio output while the Tone Search or DCS Search Scanner is activated. | ON/OFF   | ON       |
| 35: TS SPEED | Selects the Tone Search or DCS Search Scanner speed.   | FAST/SLOW  | FAST     |
| 36: LOCK     | Selects the Control Locking Lockout combination.   | KEY+DIAL/PTT/<br>KEY+PTT/DIAL+PTT/<br>ALL/KEY/DIAL   | KEY+DIAL |
| 37: STEP     | Sets the frequency synthesizer steps.  | AUTO/5/6.25/10/12.5/<br>15/20/25/50/100 (kHz)  | AUTO     |
| 38: TOT      | Sets the Time-Out Timer.   | 0.5 to 10.0 (MIN)/OFF  | ×        |
| 39: TEMP     | Indicates the current temperature inside the transceiver.  | ---  | ---      |

## Setup (Menu) Mode

| Menu Item    | Function   | Available Values | Default |
|--------------|--|------------------|---------|
| 40: VOLT     | Indicates the DC Supply Voltage.                                   | ---              | ---     |
| 41: VER DISP | Displays the transceiver software version                          | CPU x.xx         | ---     |
| 42: WIDTH    | Reduction of the Microphone Gain/Deviation and receiver bandwidth. | WIDE/NARROW      | WIDE    |
| 43: WX ALERT | Enables/Disables the Weather Alert feature.                        | ON/OFF           | OFF     |
| 44: WX VOL   | Selects the audio output level of the Weather Alert.               | NOR VOL/MAX VOL  | NOR VOL |

※: Depends on the transceiver version.

## Maintenance

### Care and maintenance

Turn the power OFF before wiping away any dust and stains on the transceiver with a dry soft cloth. For stubborn stains, slightly moisten a soft cloth and wring it out before using it to wipe away the stains.

**Caution:** Never use washing detergents and organic solvents (thinner, benzene, etc.). Doing so may result in paint flaking or damage to the transceiver finish.

### Replacing the fuse

When the fuse of the DC power supply cable blows and the transceiver becomes inoperable, correct the cause of the problem, and then replace the fuse with a new one of the correct rating (USA version: 25 Amp, Asian/European version: 20 Amp).

**Caution:** When replacing the fuse, be sure to disconnect the power supply cable from the transceiver and from the external DC power supply.

#### **Replacing the fuse of the DC power supply cable**

1. Prepare a new fuse.

Use a fuse with a rating of 25A or 20A.

**Caution:** Never attempt to use a fuse that is not of the specified rating.

**USA version:** 25 Amp

**Asian/European version:** 20 Amp

2. Open the fuse holder as shown in the diagram on the right.
3. Remove the blown fuse.
4. Attach the new fuse.
5. Close the fuse holder.

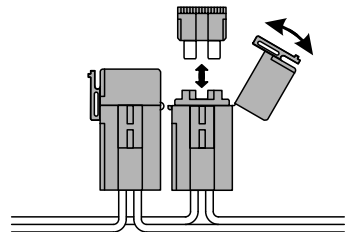

## General

|                                |  |
|--------------------------------|--|
| Frequency Range:               | Tx 144 - 146MHz or 144 - 148MHz<br>Rx 136 - 174MHz                                 |
| Channel Step:                  | 5/6.25/10/12.5/15/20/25/50/100kHz  |
| Standard Repeater Shift:       | ±600kHz  |
| Frequency Stability:           | ±10 ppm [-4°F to +140°F (-20°C to +60°C)]  |
| Modes of Emission:             | F2D, F3E   |
| Antenna Impedance:             | 50 Ohms, unbalanced  |
| Supply voltage:                | 13.8V DC ±15%, negative ground   |
| Current Consumption (typical): | Rx: less than 0.7A, less than 0.5A (squelched)<br>Tx: 11A (65W) /8A (30W) /5A (5W) |
| Operating Temperature Range:   | -4°F to +140°F (-20°C to +60°C)  |
| Case Size (WxHxD):             | 6.1" x 1.7" x 6.1" (154 x 43 x 155 mm) (w/o knobs)                                 |
| Weight (Approx.):              | 2.86 lb (1.3kg)  |

## Transmitter

|                       |  |
|-----------------------|--|
| Output Power:         | 65W/30W/5W   |
| Modulation Type:      | Variable Reactance   |
| Maximum Deviation:    | ±5kHz (Wide)<br>±2.5kHz (Narrow)                                 |
| Spurious Radiation:   | Better than -60dB<br>Better than -61.1dB (European version, 65W) |
| Microphone Impedance: | 2k Ohms  |

## Receiver

|                               |  |
|-------------------------------|--|
| Circuit Type:                 | Double Conversion Superheterodyne                    |
| I <sub>f</sub> s:             | 1st 47.25MHz, 2nd 450kHz                             |
| Sensitivity (for 12dB SINAD): | 0.20μV (Ham band, wide)<br>0.22μV (Ham band, narrow) |
| Selectivity (-6/-60dB):       | 12kHz/28kHz  |
| Maximum AF Output:            | 5W @ 13.8V, 10% THD                                  |

Rated values are at normal temperature and pressure.  
Ratings and specifications are subject to change without notice.

## Symbols placed on the equipment

**---** Direct current

## YAESU LIMITED WARRANTY

Limited Warranty is valid only in the country/region where this product was originally purchased.

### **On-line Warranty Registration:**

Thank you for buying YAESU products! We are confident your new radio will serve your needs for many years! Please register your product at [www.yaesu.com](http://www.yaesu.com) - Owner's Corner

### **Warranty Terms:**

Subject to the Limitations of the Warranty and the Warranty Procedures described below, YAESU MUSEN hereby warrants this product to be free of defects in materials and workmanship in normal use during the "Warranty Period." (the "Limited Warranty").

### **Limitations of Warranty:**

- A. YAESU MUSEN is not liable for any express warranties except the Limited Warranty described above.
- B. The Limited Warranty is extended only to the original end-use purchaser or the person receiving this product as a gift, and shall not be extended to any other person or transferee.
- C. Unless a different warranty period is stated with this YAESU product, the Warranty Period is three years from the date of retail purchase by the original end-use purchaser.
- D. The Limited Warranty is valid only in the country/region where this product was originally purchased.
- E. During the Warranty Period, YAESU MUSEN will, at its sole option, repair or replace (using new or refurbished replacement parts) any defective parts within a reasonable period of time and free of charge.
- F. The Limited Warranty does not cover shipping cost (including transportation and insurance) from you to us, or any import fees, duties or taxes.
- G. The Limited Warranty does not cover any impairment caused by tampering, misuse, failure to follow instructions supplied with the product, unauthorized modifications, or damage to this product for any reasons, such as: accident; excess moisture; lightning; power surges; connection to improper voltage supply; damage caused by inadequate packing or shipping procedures; loss of, damage to or corruption of stored data; product modification to enable operation in another country/purpose other than the country/purpose for which it was designed, manufactured, approved and/or authorized; or the repair of products damaged by these modifications.
- H. The Limited Warranty applies only to the product as it existed at the time of the original purchase, by the original retail purchaser, and shall not preclude YAESU MUSEN from later making any changes in design, adding to, or otherwise improving subsequent versions of this product, or impose upon YAESU MUSEN any obligation to modify or alter this product to conform to such changes, or improvements.
- I. YAESU MUSEN assumes no responsibility for any consequential damages caused by, or arising out of, any such defect in materials or workmanship.
- J. TO THE FULLEST EXTENT PERMITTED BY LAW, YAESU MUSEN SHALL NOT BE RESPONSIBLE FOR ANY IMPLIED WARRANTY WITH RESPECT TO THIS PRODUCT.
- K. If the original retail purchaser timely complies with the Warranty Procedures described below, and YAESU MUSEN elects to send the purchaser a replacement product rather than repair the "original product", then the Limited Warranty shall apply to the replacement product only for the remainder of the original product Warranty Period.
- L. Warranty statutes vary from state to state, or country to country, so some of the above limitations may not apply to your location.

**Warranty Procedures:**

1. To find the Authorized YAESU Service Center in your country/region, visit [www.yaesu.com](http://www.yaesu.com). Contact the YAESU Service Center for specific return and shipping instructions, or contact an authorized YAESU dealer/distributor from whom the product was originally purchased.
2. Include proof of original purchase from an authorized YAESU dealer/distributor, and ship the product, freight prepaid, to the address provided by the YAESU Service Center in your country/region.
3. Upon receipt of this product, returned in accordance with the procedures described above, by the YAESU Authorized Service Center, all reasonable efforts will be expended by YAESU MUSEN to cause this product to conform to its original specifications. YAESU MUSEN will return the repaired product (or a replacement product) free of charge to the original purchaser. The decision to repair or replace this product is the sole discretion of YAESU MUSEN.

**Other conditions:**

YAESU MUSEN'S MAXIMUM LIABILITY SHALL NOT EXCEED THE ACTUAL PURCHASE PRICE PAID FOR THE PRODUCT. IN NO EVENT SHALL YAESU MUSEN BE LIABLE FOR LOSS OF, DAMAGE TO OR CORRUPTION OF STORED DATA, OR FOR SPECIAL, INCIDENTAL, CONSEQUENTIAL, OR INDIRECT DAMAGES, HOW EVER CAUSED; INCLUDING WITHOUT LIMITATION TO THE REPLACEMENT OF EQUIPMENT AND PROPERTY, AND ANY COSTS OF RECOVERING, PROGRAMMING OR REPRODUCING ANY PROGRAM OR DATA STORED IN OR USED WITH THE YAESU PRODUCT.

Some Countries in Europe and some States of the USA do not allow the exclusion or limitation of incidental or consequential damages, or a limitation on how long an implied warranty lasts, so the above limitation or exclusions may not apply. This warranty provides specific rights, there may be other rights available which may vary between countries in Europe or from state to state within the USA.

This Limited Warranty is void if the label bearing the serial number has been removed or defaced.

1. Changes or modifications to this device that are not expressly approved by YAESU MUSEN could void the user's authorization to operate this device.
2. This device complies with part 15 of the FCC Rules. Operation is subject to the following two conditions: (1) This device may not cause harmful interference, and (2) this device must accept any interference including received, interference that may cause undesired operation.
3. The scanning receiver in this equipment is incapable of tuning, or readily being altered, by the User to operate within the frequency bands allocated to the Domestic public Cellular Telecommunications Service in Part 22.

#### **DECLARATION BY MANUFACTURER**

The Scanner receiver is not a digital scanner and is incapable of being converted or modified to a digital scanner receiver by any user.

**WARNING:** MODIFICATION OF THIS DEVICE TO RECEIVE CELLULAR RADIOTELEPHONE SERVICE SIGNALS IS PROHIBITED UNDER FCC RULES AND FEDERAL LAW.

CAN ICES-3 (B) / NMB-3 (B)

This equipment has been tested and found to comply with the limits for a Class B digital device, pursuant to part 15 of the FCC Rules. These limits are designed to provide reasonable protection against harmful interference in a residential installation. This equipment generates uses and can radiate radio frequency energy and, if not installed and used in accordance with the instructions, may cause harmful interference to radio communications. However, there is no guarantee that interference will not occur in a particular installation.

If this equipment does cause harmful interference to radio or television reception, which can be determined by turning the equipment off and on, the user is encouraged to try to correct the interference by one or more of the following measures:

- Reorient or relocate the receiving antenna.
- Increase the separation between the equipment and receiver.
- Connect the equipment into an outlet on a circuit different from that to which the receiver is connected.
- Consult the dealer or an experienced radio/TV technician for help.

# ***YAESU***

## **Declaration of Conformity**

Type of Equipment: VHF FM Transceiver

Brand Name: YAESU

Model Number: FT-3165R

Manufacturer: YAESU MUSEN CO., LTD.

Address of Manufacturer: Omori Bell port D building 3F, 6-26-3 Minamioi,  
Shinagawa-ku, Tokyo 140-0013 JAPAN

This device complies with part 15 of the FCC Rules. Operation is subject to the following two conditions; (1) this device may not cause harmful interference, and (2) this device must accept any interference received, including interference that may cause undesired operation. The technical documentation as required by the Conformity Assessment procedures is kept at the following address:

Company: Yaesu U.S.A.

Address: 6125 Phyllis Drive, Cypress, CA 90630, U.S.A.

Telephone: (714) 827-7600

## **EU Declaration of Conformity**

We, Yaesu Musen Co. Ltd of Tokyo, Japan, hereby declare that this radio equipment FT-3165E is in full compliance with EU Radio Equipment Directive 2014/53/EU. The full text of the Declaration of Conformity for this product is available to view at <http://www.yaesu.com/jp/red>

## **ATTENTION – Conditions of usage**

This transceiver operates on frequencies that are regulated. Use of the Transmitter in the EU countries shown in the accompanying table is not permitted without authorization. Users should consult their local spectrum management authority for licensing conditions applicable to this equipment.

|  |    |    |    |    |    |
|---|----|----|----|----|----|
| AT  | BE | BG | CY | CZ | DE |
| DK  | ES | EE | FI | FR | GR |
| HR  | HU | IE | IT | LT | LU |
| LV  | MT | NL | PL | PT | RO |
| SK  | SI | SE | CH | IS | LI |
| NO  | -  | -  | -  | -  | -  |

## **Disposal of Electronic and Electrical Equipment**

Products with the symbol (crossed-out wheeled bin) cannot be disposed as household waste.

Electronic and Electrical Equipment should be recycled at a facility capable of handling these items and their waste by-products.

Please contact a local equipment supplier representative or service center for information about the waste collection system in your country.



# ***YAESU***

***Radio for Professionals***

Copyright 2024  
YAESU MUSEN CO., LTD.  
All rights reserved.

No portion of this manual may be  
reproduced without the permission of  
YAESU MUSEN CO., LTD.

## **YAESU MUSEN CO., LTD.**

Omori Bellport Building D-3F  
6-26-3 Minami-Oi, Shinagawa-ku, Tokyo, 140-0013, Japan

## **YAESU USA**

6125 Phyllis Drive, Cypress, CA 90630, U.S.A.

## **YAESU UK**

Unit 4, Concorde Park, Concorde Way, Segensworth North,  
Fareham, Hampshire PO15 5FG, United Kingdom

2410G-BS-1  
Printed in Japan

