

TI-3000

USB Transceiver
Interface

RigExpert®

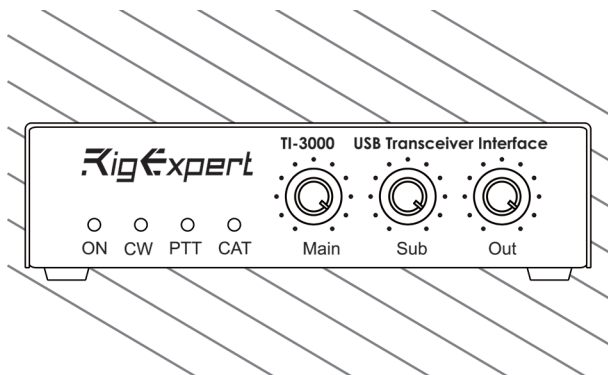

User's manual

Table of contents

Introduction	4
Operating the TI-3000	6
Front and rear panels	6
Transceiver and computer connection	8
Annexes	10
Annex 1: Specifications	10
Annex 2: Adjusting input and output audio levels	12

Introduction

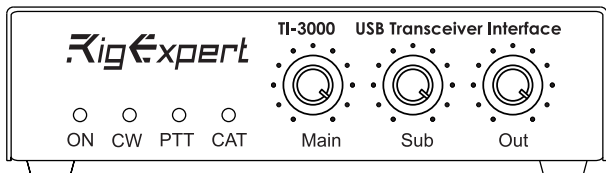

Thank you for purchasing a **RigExpert TI-3000** USB Transceiver Interface! We did our best to make it powerful yet easy to use.

RigExpert TI-3000 is a device for operating phone, CW and digital modes using personal computer with USB port.

It provides:

- **Transceiver audio interface**

Analog audio interface is a connection to transceiver audio output (external speaker connector or line output) and transceiver audio input (microphone connector or line input). Audio interface enables operating digital modes, as well as other useful functions (such as measuring levels of a signal from the air) by using a computer.

Input (main and sub channels) and output volume levels are adjusted by potentiometers on the front panel of the device.

- **CAT interface for various transceiver models**

CAT (Computer Aided Transceiver) system provides control of transceiver frequency, operating mode and other functions by computer software. Normally, modern transceivers have serial (with various signal levels) link providing CAT interface.

A separate COM port is created for the CAT system so the computer software can communicate to the transceiver.

- **PTT and CW output functions**

Transceivers provide PTT (Push To Talk) and CW (Continuous Wave) keyer inputs to allow setting the transmitter on or off and operating CW using external device (PTT pedal, CW bug or paddle, terminal node controller, or personal computer).

A separate COM port is created for PTT/ CW outputs.

- **Squelch input**

Some software, such as EchoLink, requires the interface to provide a squelch input to detect if the radio channel is busy.

In RigExpert TI-3000, the squelch input is assigned to the DCD line of the COM port used for PTT and CW outputs.

Operating the TI-3000

Front and rear panels

Front panel:

1. ON. Lights when the RigExpert TI-3000 device is plugged in and the drivers are installed.
2. CW. Shows transmissions in CW mode.
3. PTT. Indicates when the transceiver transmits.
4. CAT. Monitors CAT data exchange between transceiver and computer.
5. Main. Input level, channel 1 (main receiver audio).
6. Sub. Input level, channel 2 (sub-receiver audio).
7. Out. Output level (audio to the transceiver).

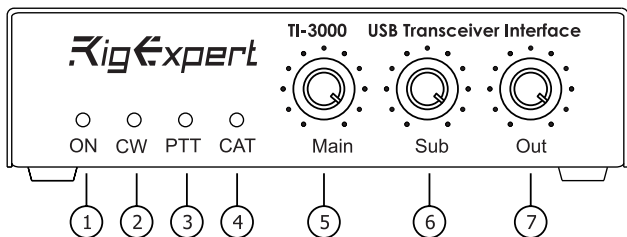

Rear panel:

8. TRANSCEIVER. 25-pin transceiver connector.

9. USB IN. Connect to the computer USB port.

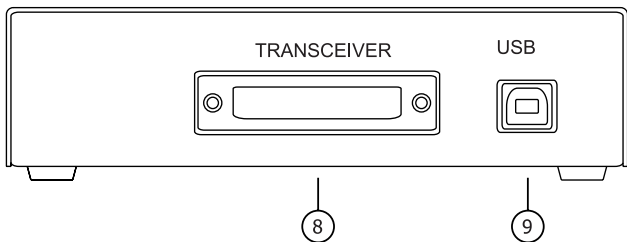

Transceiver and computer connection

The connection to your transceiver is made by using a specialized cable. A specific type of the cable depends on the manufacturer and the model of the transceiver.

Please watch the marking to make sure all plugs are inserted properly to corresponding sockets located on your transceiver.

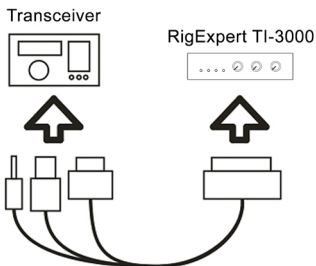

You may either order a transceiver cable with your TI-3000 or assemble it yourself. See the schematic diagrams on our website, www.rigexpert.com.

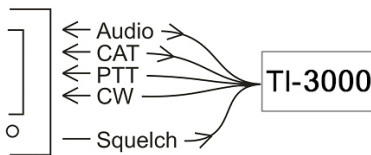

A number of analog and digital signals are routed between your transceiver and RigExpert TI-3000. Cables for most modern rigs (Icom, Kenwood, Yaesu, Ten-Tec, Elecraft) are available; future rigs are supported by design of the universal 25-pin connector of RigExpert TI-3000.

The squelch connection is not available in all cables manufactured by our company. The user has to add this connection, if necessary.

Use a standard USB A-B cable (up to 5 meters long) to connect your RigExpert TI-3000 to a USB port of your computer. It is recommended to use USB sockets located at the back panel of the PC.

Once the cable is connected, computer detects a new device. No drivers required for modern operating systems.

More info on www.rigexpert.com/ti-3000.

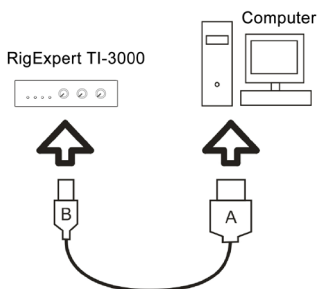

Now your TI-3000 is ready for use!

Annex 1

Specifications

General features:

- Transceiver audio interface for operating digital modes
- CAT (Computer Aided Transceiver) system
- PTT and CW outputs
- Squelch input

Computer connection:

- USB (Universal Serial Bus) connector
- Powered from the USB port (consuming 100 mA maximum)
- No external power supply needed

Audio interface:

- Insulated from digital nets
- Maximum input/output amplitude is 1V
- Input/output samplerate: 8 to 48 kHz
- True 16-bit DAC/ADC used
- Volume levels are adjusted by the front panel potentiometers

CAT serial port:

- Baudrate: 300-115200 baud
- Electrical compatibility: RS-232, CI-V, TTL or inverted-TTL (Yaesu, Icom, Kenwood, Ten-Tec, Elecraft and JRC transceivers)

PTT/CW outputs:

- PTT output: open collector and TTL-level
- CW output: open collector
- Maximum current is 500 mA

System requirements:

- Desktop or laptop computer with USB 1/2/3 compliant port
- Windows XP/Vista/7/8/10 (32 or 64-bit), Mac OS or Linux operating system

Transceiver connection:

- Single 25-pin connector for transceiver cable
- Various transceiver models supported

Dimensions: 145x 110x 40 mm
(5.7 × 4.9 × 1.6 in)

Operating temperature: 0...40 °C
(32...104 °F)

Weight: 200 g (7.05 oz)

Warranty: 2 years

RigExpert TI-3000 is made in Ukraine.

Annex 2

Adjusting input and output audio levels

You can adjust input and output audio levels by regulators on the front panel. However, it is possible to increase range of input and output audio levels by using 6 switches which are located on bottom side of TI-3000.

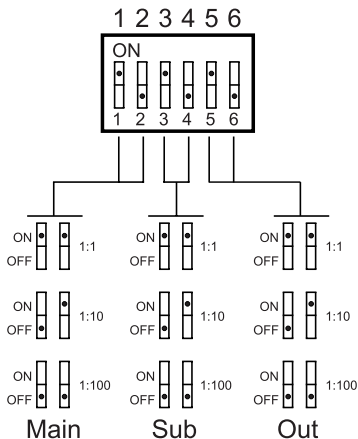

<http://www.rigexpert.com>

Copyright © 2019 Rig Expert Ukraine Ltd.

“RigExpert” is a registered trademark of Rig Expert Ukraine Ltd.



Doc. date: 27-Nov-2019